

Instructions for Use

ENSPRYNG™ (en-spryng) (satralizumab-mwge) Injection

Read this Instructions for Use before you start using your prefilled syringe and each time you get a refill. There may be new information. This information does not take the place of talking to your healthcare provider about your medical condition or treatment. Your healthcare provider will decide if you or a caregiver can give you injections of ENSPRYNG at home. They will also show you or a caregiver the correct and safe way to use the syringe before you use it for the first time.

Talk to your healthcare provider if you have any questions.

Important Information

- Each syringe is prefilled with a medicine called ENSPRYNG.
- Each carton of ENSPRYNG contains only 1 prefilled syringe.
- Each prefilled syringe can be used only 1 time.

Do not share your ENSPRYNG syringe with other people. You may give them a serious infection or get a serious infection from them.

Do not:

- take the needle cap off until you are ready to inject ENSPRYNG.
- use the syringe if it has been dropped or damaged.
- try to take the syringe apart at any time.
- leave the syringe unattended.
- re-use the same syringe.

How should I store the ENSPRYNG prefilled syringe?

- Keep the unused syringe in the refrigerator between **36°F to 46°F (2°C to 8°C)** until ready to use.
- Before giving an injection, if the ENSPRYNG is not opened, it can be removed from and placed back in the refrigerator if needed. The total combined time out of the refrigerator should not be more than 8 days at a temperature that does not go above 86°F (30°C).
- Keep the syringe in its original carton away from direct sunlight.
- Always keep the syringe dry.

Keep the ENSPRYNG syringe and all medicines out of the reach of children.

Do not:

- freeze the syringe.
- use the syringe if it has been frozen.
- shake.

Supplies needed to give your injection

Each ENSPRYNG carton contains:

- 1 prefilled syringe for 1-time use only.

Not included in the carton:

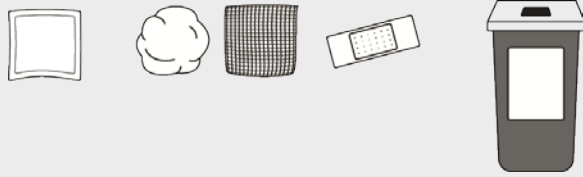

- 1 alcohol pad
- 1 sterile cotton ball or gauze
- 1 small bandage
- 1 FDA-cleared puncture-resistant sharps container for safe disposal of the needle cap and used syringe. See Step 21 "Disposing of ENSPRYNG" at the end of this Instructions for Use.

ENSPRYNG prefilled syringe

(See Figure A and Figure B)

Before use:

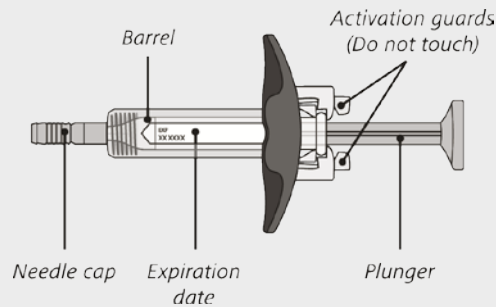

Figure A

After use:

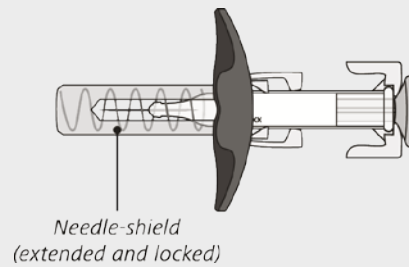

Figure B

The syringe has a needle-shield that automatically covers the needle when the injection is complete.

Prepare to use ENSPRYNG

1. Take the carton containing the syringe out of the refrigerator and place it on a clean, flat work surface (like a table).
2. Check the expiration (EXP) date on the back of the carton (**See Figure C**). **Do not** use if the carton has expired.
3. Check the front of the carton to make sure it is sealed (**Figure C**). **Do not** use if the seal has been broken.

If the expiration date has passed or the seal is broken, do not use. Then go to Step 21 “Disposing of ENSPRYNG” and contact your healthcare provider.

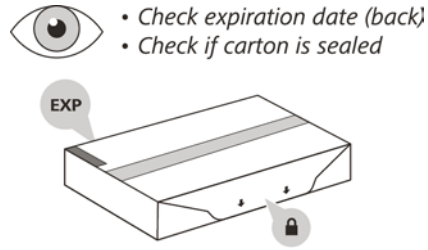

Figure C

4. Open the sealed carton (**See Figure D**).

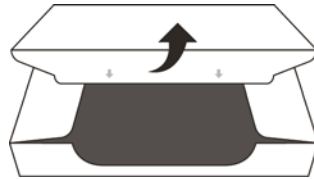

Figure D

5. Carefully lift the syringe out of the carton by holding the barrel (**See Figure E**).

Do not:

- turn the carton upside down to remove the syringe.
- touch the activation guards because this may damage the syringe.
- hold the plunger or needle cap.

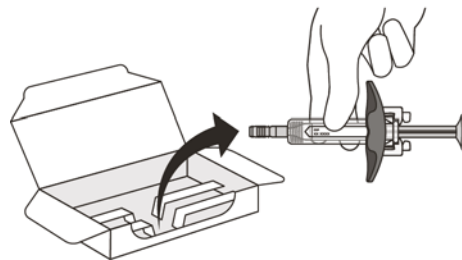

Figure E

Check the syringe

(See Figure F)

6. Check the expiration date on the syringe. **Do not** use the syringe if it has expired.
7. Check the syringe for any damage. **Do not** use if it is cracked or broken.
8. Check that the liquid through the viewing window is clear and colorless to slightly yellow. **Do not** inject the medicine if the liquid is cloudy, discolored, or has particles in it.
 - There may be some small air bubbles in the syringe. This is normal and you should not try to remove them.

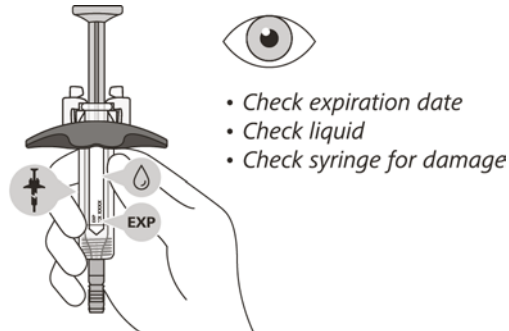

Figure F

If the expiration (EXP) date has passed, the syringe is damaged or the liquid is cloudy, discolored or has particles in it, do not use. Then go to Step 21 “Disposing of ENSPRYNG” and contact your healthcare provider.

Let your syringe warm up

9. After you have checked the syringe, place it on a clean, flat work surface (like a table) for **30 minutes**. This will allow it to reach room temperature. (See Figure G).

It is important to let the syringe gently warm up as injecting cold medicine may feel uncomfortable and make it harder to push.

Do not:

- speed up the warming process in any way, such as using a microwave or placing the syringe in warm water.
- remove the needle cover while the syringe is reaching room temperature.



Wash your hands

10. Wash your hands with soap and water. **(See Figure H).**



Figure H

Choose the injection site

11. Choose your injection site in either:

- the lower part of your stomach (abdomen) or
- the front and middle of your thighs. **(See Figure I).**



Figure I

- **Do not** inject into the 2-inch (5 cm) area around your belly button.
- **Do not** inject into moles, scars, bruises, or areas where the skin is tender, red, hard or broken.

Choose a different injection site for **each new injection**. Choose a different place to inject which is at **least 1 inch (2.5 cm) away from the place where you last injected.**

Clean the injection site

12. Wipe the injection site with an alcohol pad and let it air dry.

Do not:

- fan or blow on the area which you have cleaned.
- touch the injection site again before you give the injection.

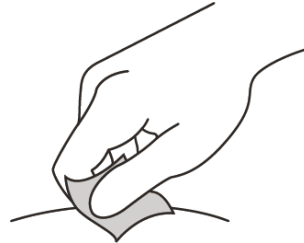

Figure J

Inject ENSPRYNG

13. Hold the barrel of the syringe between your thumb and index finger. With your other hand, pull the needle cap straight off. You may see a drop of liquid at the end of the needle. This is normal and will not affect your dose (**See Figure K**).

- **Use the syringe within 5 minutes of removing the cap or the needle may clog.**

Do not:

- take the needle cap off until you are ready to inject ENSPRYNG.
- put the needle cap back on after it has been removed as this may damage the needle.
- touch the needle or let it touch any surfaces after removing the needle cap.

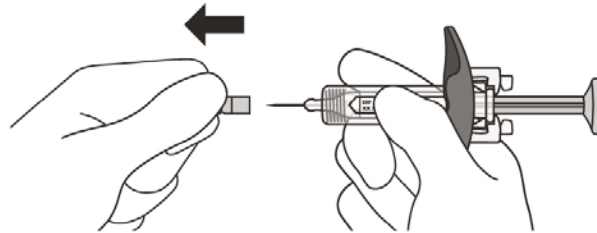

Figure K

14. Throw away the needle cap in a puncture-resistant sharps container immediately. See Step 21 “Disposing of ENSPRYNG”.

15. Hold the barrel of the syringe using your thumb and index finger. With your other hand, pinch the area of skin you have cleaned (**See Figure L**).

16. Use a quick, dart-like motion to insert the needle at an angle between 45° to 90° (See Figure L).

Do not:

- insert the needle through clothing.
- change the angle of the injection.
- insert the needle again.

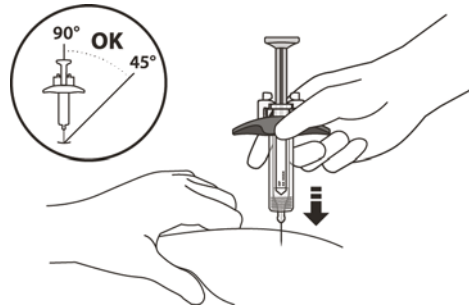

Figure L

17. After the needle is inserted, let go of the pinched skin.

18. Slowly inject all of the medicine by gently pushing the plunger all the way down until it touches the activation guards (See Figure M).

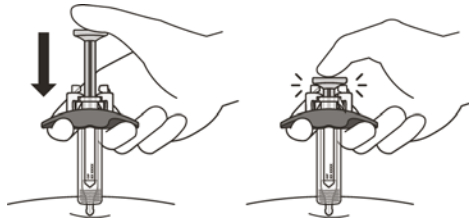

Figure M

19. Gently release the plunger and allow the needle to come out of the skin at the same angle it was inserted (See Figure N).

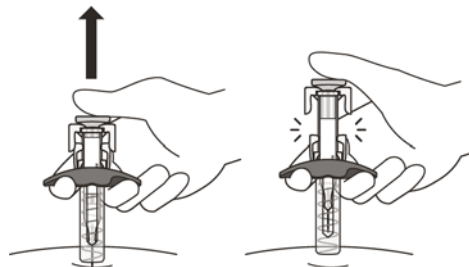

Figure N

- **The needle will now be covered by the needle-shield.** If the needle is not covered, carefully place the syringe into a puncture-resistant sharps container to avoid injury. See Step 21 “Disposing of ENSPRYNG”.

Taking care of the injection site

20. There may be a little bleeding at the injection site. You can press a cotton ball or gauze over the injection site but **do not** rub it. If needed, you may also cover the area you injected with a small bandage. If the medicine gets into contact with your skin, wash the area with water.

Disposing of ENSPRYNG

21. Put your used syringe in an FDA-cleared sharps disposal container immediately after use (**See Figure O**). **Do not** throw away (dispose of) the syringe in your household trash.



Figure O

- If you **do not** have an FDA-cleared sharps disposal container, you may use a household container that is:
 - made of a heavy-duty plastic
 - can be closed with a tight-fitting, puncture-resistant lid, without sharps being able to come out
 - upright and stable during use
 - leak-resistant
 - properly labeled to warn of hazardous waste inside the container
- When your sharps disposal container is almost full, you will need to follow your community guidelines for the right way to dispose of your sharps disposal container. There may be state or local laws about how you should throw away used needles and syringes. For more information about the safe sharps disposal, and for specific information about sharps disposal in the state that you live in, go to the FDA's website at: <http://www.fda.gov/safesharpsdisposal>.
- **Do not** dispose of your used sharps disposal container in trash unless your community guidelines permit this.
- **Do not** recycle your used sharps disposal container.

This Instructions for Use has been approved by the U.S. Food and Drug Administration.

Manufactured by:

Genentech, Inc.

A Member of the Roche Group

1 DNA Way

South San Francisco, CA 94080-4990

U.S. License No.: 1048

Approved: 8/2020

ENSPRYNG is a trademark of Chugai Pharmaceutical Co., Ltd., Tokyo, Japan

© 2020 Genentech, Inc. All rights reserved.